

# Surface Modeling

With all of its powerful feature creation tools, solid modeling is not capable of capturing the complex shapes. To capture such complex shapes, surface modeling techniques are widely used.

**Surface Modeling Tutorials** have been developed to teach a user the required tools, Pro/ENGINEER provides to build complex surface models. The self-study course starts from the very basic concepts and teaches advanced concepts step-by-step with the help of examples. A great emphasis is placed on building the tangent and curvature continuous surfaces to give an appealing look to the viewer. The concept of surface quality has been explained in a very clear and effective way. The tools offered by Pro/ENGINEER for analyzing the surface quality have been elaborated with examples. After completing these tutorials an Engineer or Designer will be able to start a real-world design project from concept and progress it to complete highly aesthetic surface model.

Pro/E has two modules for building surface; Pro/SURFACE and ISDX. ISDX is used for building free form surfaces. In this text we will learn to create the parametric surfaces using Pro/SURFACE module.

The training material is divided into sections listed below. CAD models are accompanied for the user practice. Finished models are also supplied to compare the work done by the user. Finished models are like a mine of information and techniques. You can learn a lot just by looking at how features have been created.

Please click on the topic name to view more details.

1. [Basics of Surface Modeling](#)
2. [Datum Features](#)
3. [Surface Quality and Analysis](#)
4. Examples

## Prerequisites

The only requirement to start these tutorials is basic know-how to the Pro/ENGINEER

## Stats

Following are the stats for WF 5.0

Total Pages: **685**

Total Exercises: **127**

# Basics of Surface Modeling

In this section we will learn the basic tools used to build the surfaces.

“Surface” and “Quilt” terms are frequently used while building models with surface modeling techniques. Here first we will explain the meaning and differences of these terms.

In this section we will learn the basic surface creation and manipulation tools.

## *Extrude*

### Exercise 1

The topics covered are as follows.

- Creating an extruded surface
- Trimming an existing surface with extrude tool

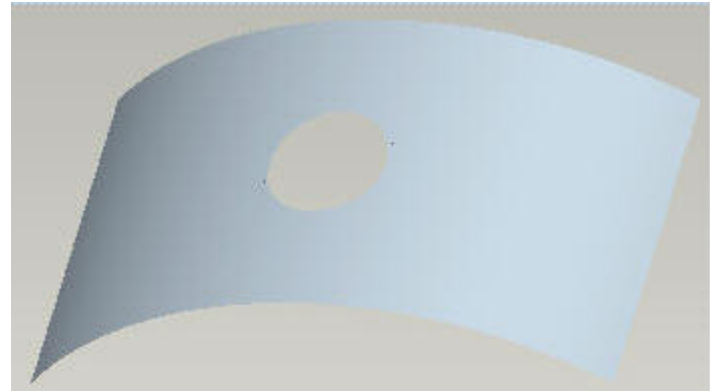

## *Revolve*

### Exercise 1

The topics covered are as follows.

- Creating a Revolved surface

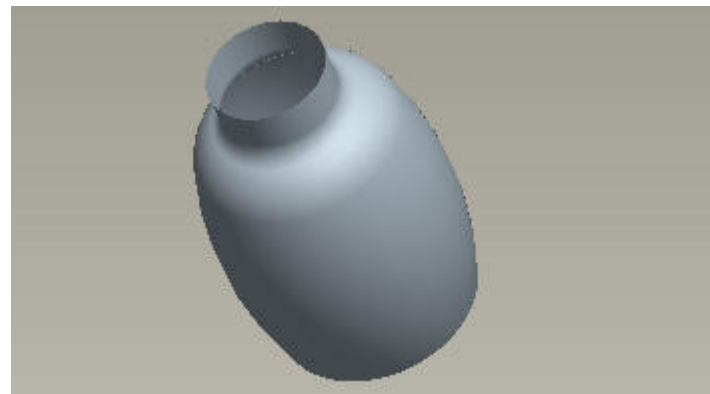

## *Fill*

### Exercise 1

The topics covered are as follows.

- Creating a flat surface with Fill tool



## *Sweep*

### Exercise 1

The topics covered are as follows.

- Creating a Sweep surface

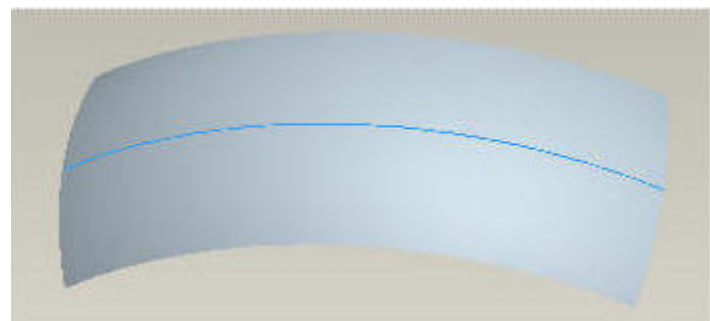

## *Variable Section Sweep*

### Exercise 1

The topics covered are as follows.

- Creating a simple variable section sweep feature



### Exercise 2

The topics covered are as follows.

- Specifying additional chains in addition to Origin Trajectory

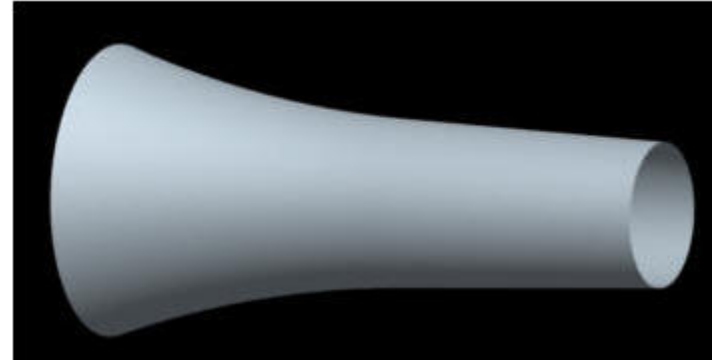

### Exercise 3

The topics covered are as follows.

- Effect of section dimensioning scheme on surface geometry

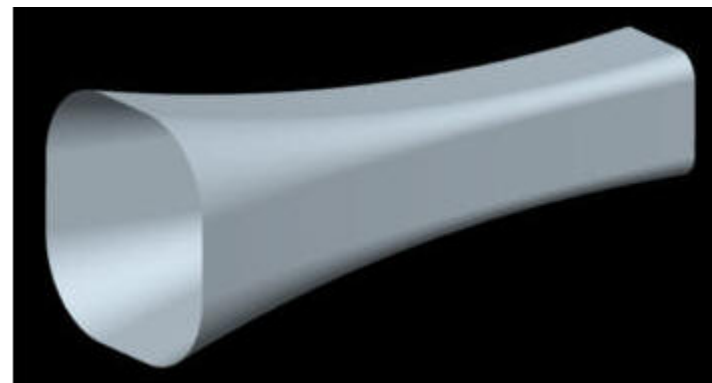

## *Blend*

### Exercise 1

The topics covered are as follows.

- Creating a blended surface



## *Swept Blend*

### Exercise 1

The topics covered are as follows.

- Creating a Swept blend surface



## *Boundary Blend*

### Exercise 1

The topics covered are as follows.

- Creating a blended surface by referencing curves in one direction

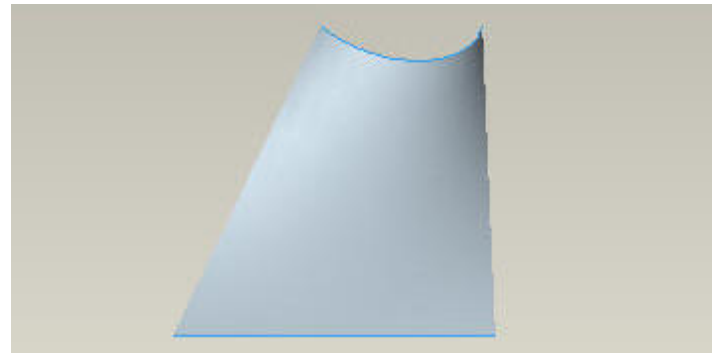

### Exercise 2

The topics covered are as follows.

- Creating a blended surface by referencing curves in two direction

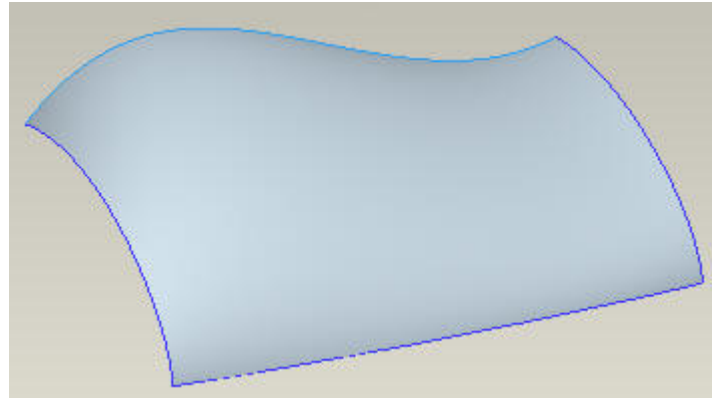

### Exercise 3

The topics covered are as follows.

- Creating a blended surface that connects two existing surface with Tangent constraint

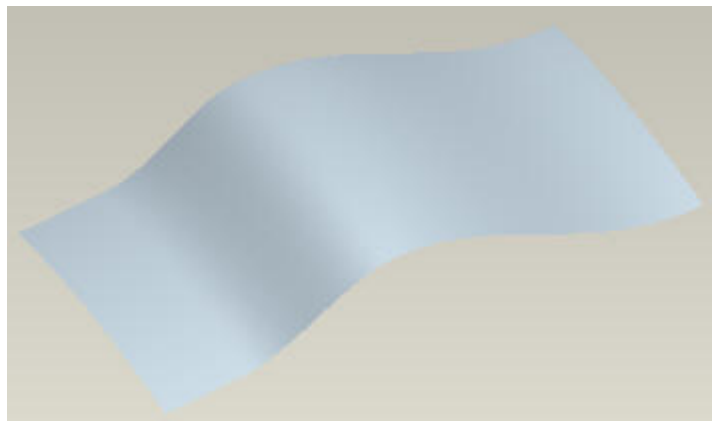

## *Offset*

### Exercise 1

The topics covered are as follows.

- Creating an Offset surface

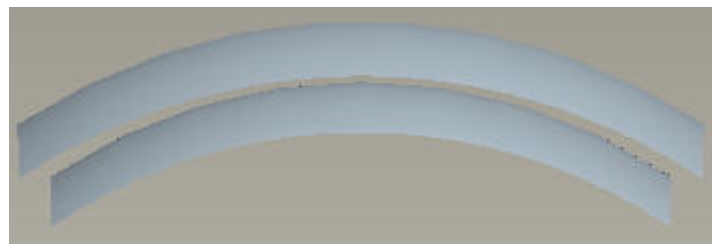

## *Copy*

### Exercise 1

The topics covered are as follows.

- Copy surfaces with Copy tool

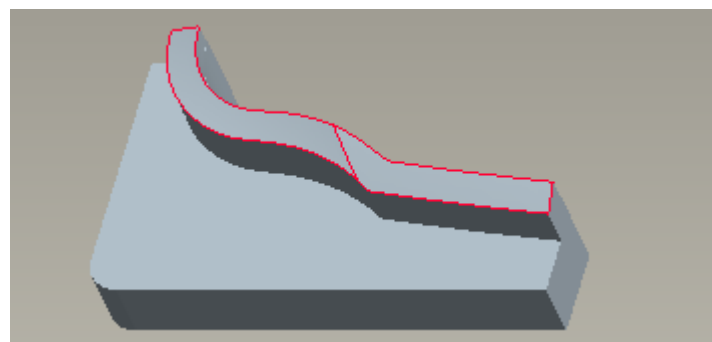

## Exercise 2

The topics covered are as follows.

- Copy surfaces
- Selecting surface with Loop selection technique

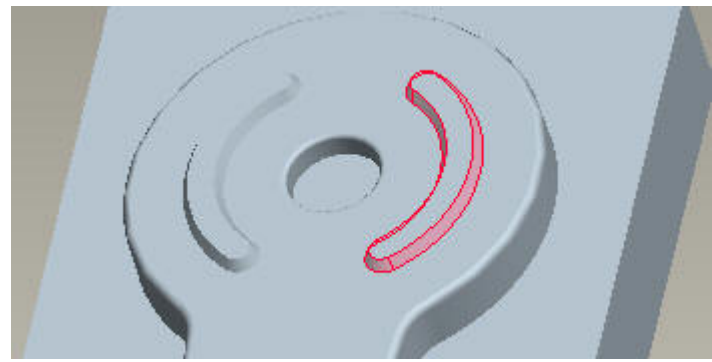

## Exercise 3

The topics covered are as follows.

- Filling a hole in a copied surface

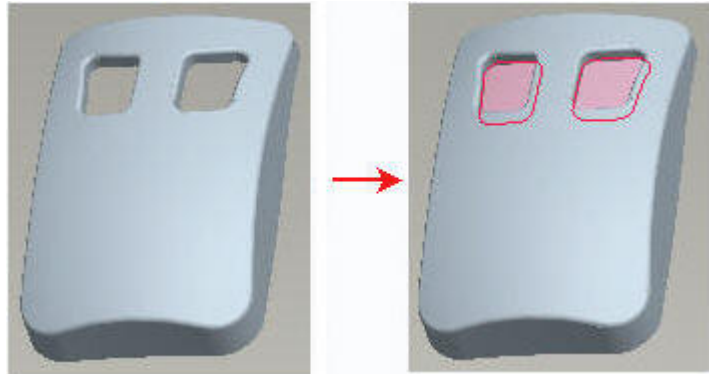

## Exercise 4

The topics covered are as follows.

- Filling holes in copied surface with Contours option

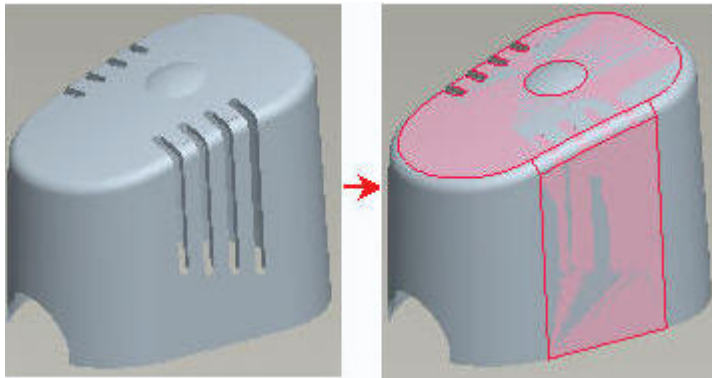

## Exercise 5

The topics covered are as follows.

- Excluding a surface patch from copied surface

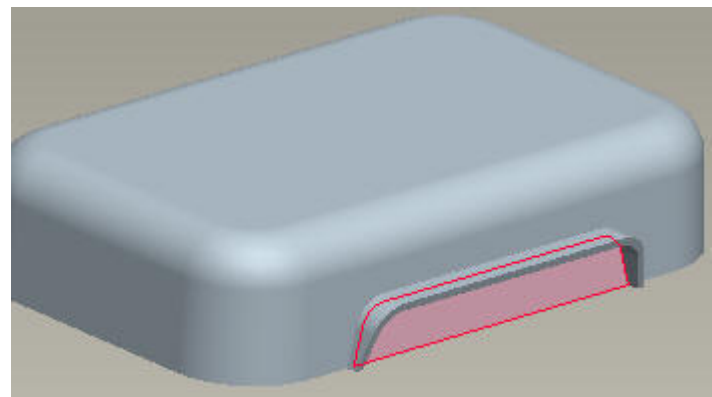

## *Mirror*

### Exercise 1

The topics covered are as follows.

- Mirroring a surface

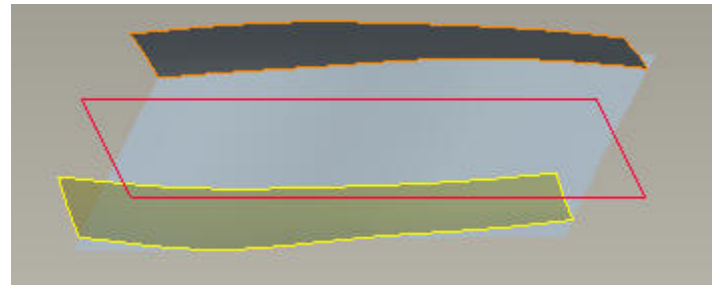

## *Move*

### Exercise 1

The topics covered are as follows.

- Translating a surface

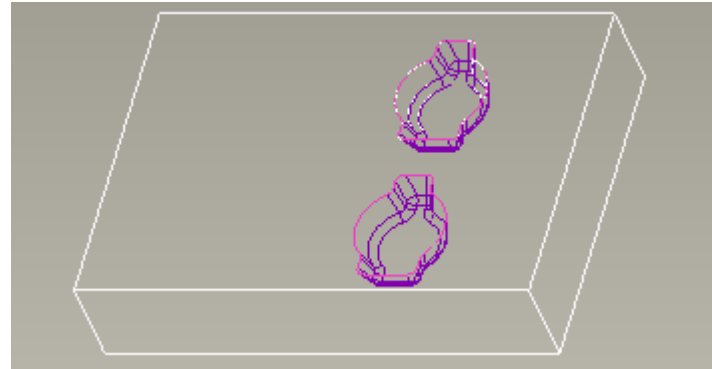

### Exercise 2

The topics covered are as follows.

- Rotating a surface

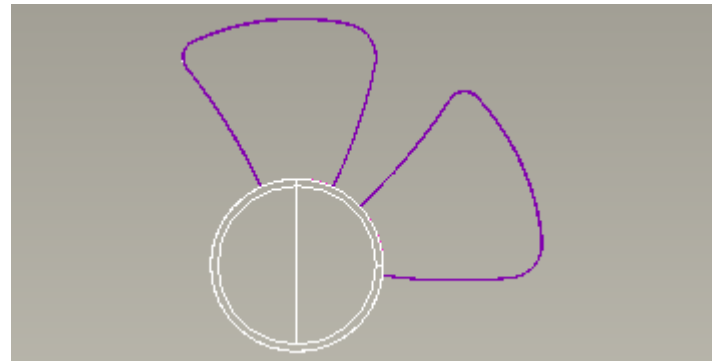

## *Merge*

### Exercise 1

The topics covered are as follows.

- Joining overlapping surface with Merge tool

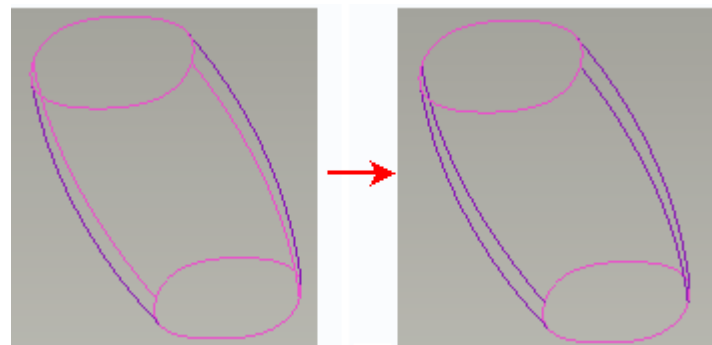

### Exercise 2

The topics covered are as follows.

- Joining the intersecting surfaces with Merge tool

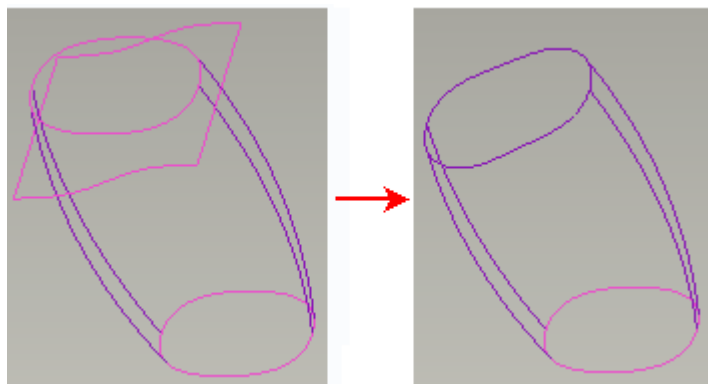

## *Trim*

### Exercise 1

The topics covered are as follows.

- Trimming a surface

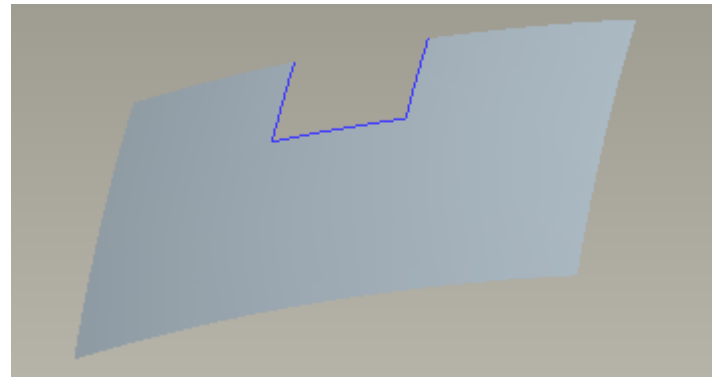

## *Extend*

### Exercise 1

The topics covered are as follows.

- Extending a surface



## *Converting Surface to Solid*

### Exercise 1

The topics covered are as follows.

- Solidifying a quilt

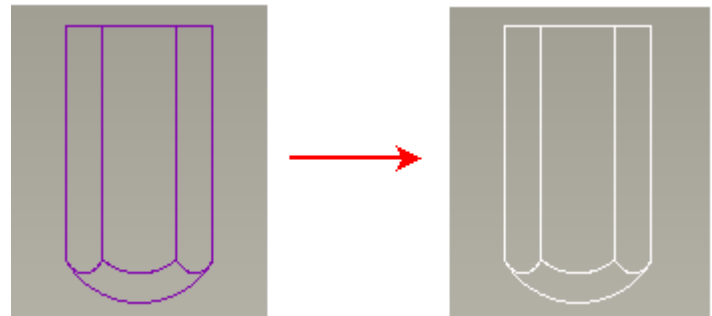

### Exercise 1

The topics covered are as follows.

- Removing material by using quilt

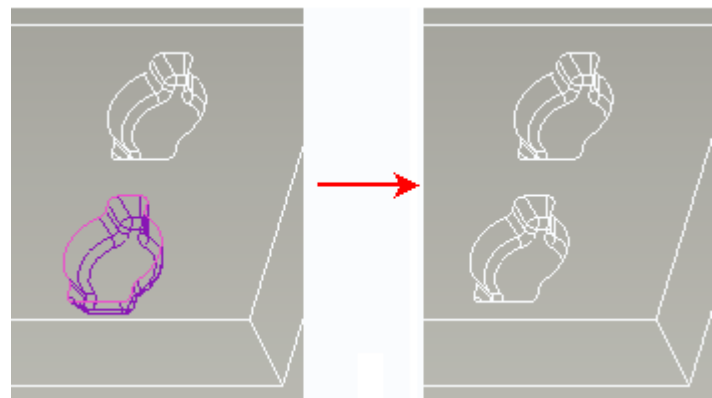

# Datum Features

Datum features are created to help build the solid or surface features. In this section we will learn about following datum features

- Datum Curves
- Datum Points
- Datum Planes
- Datum Axis
- Datum Coordinate System

## *Datum Curves*

In surface modeling datum curves are of great importance. Most of the surfaces are built around datum curves. So surface modeling requires good skills to build datum curves.

There are several exercises elaborating how to

- Sketch a spline
- Modify a spline
- Dimension the tangency of end points of a spline
- Dimension the tangency of an intermediate point of a spline
- Dimension radius of curvature of a spline
- Sketch a three point spline and dimension it
- Sketch a conic arc
- Create a datum curve that passes through the selected points
- Create a datum curve by projection
- Create a composite datum curve by copying multiple curves
- Create a curve at the intersection of two surfaces
- Wrapping a sketched curve

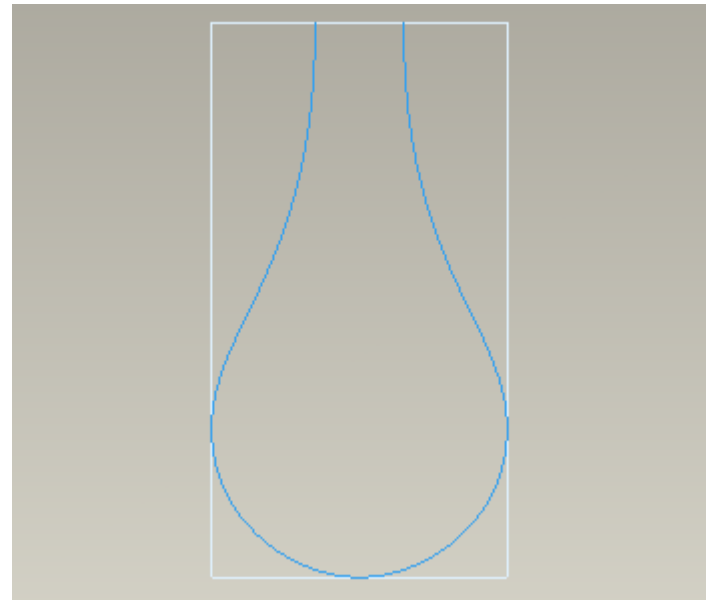

A Spline

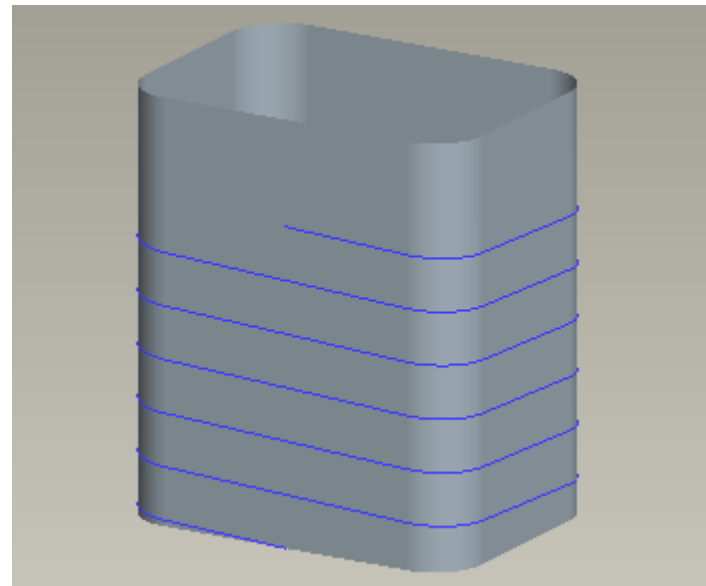

A non-circular helical curve

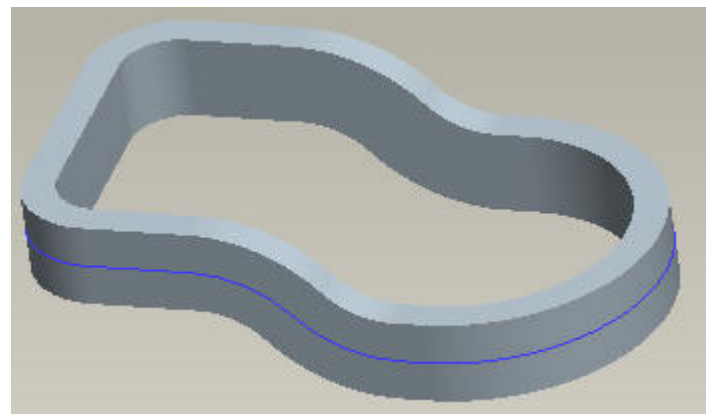

Curve projected around the periphery of the part

## Datum Points

In this section, there are several exercises elaborating how to create

- Sketched datum points
- Datum points at the center of an arc or circle
- A datum point that lies on a datum curve
- A datum point at a specific distance on a datum curve
- A datum point that lies on a vertex
- A datum point at the intersection of a surface and a datum axis
- A datum point that lies on a surface and dimensioned to datum planes
- A datum point offset from a surface
- Datum points offset from the coordinate system

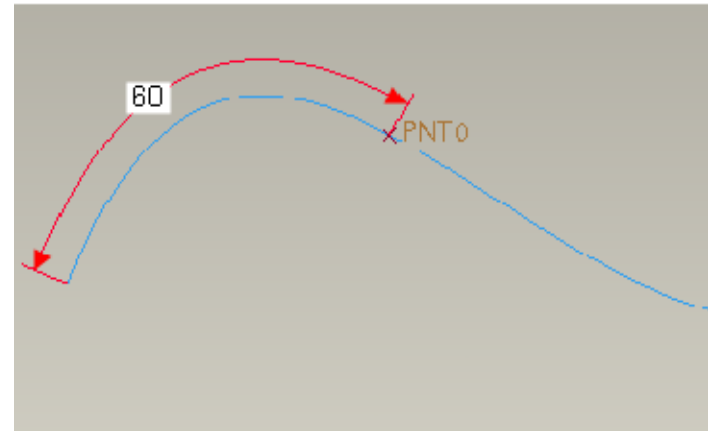

Datum Point at a specific distance

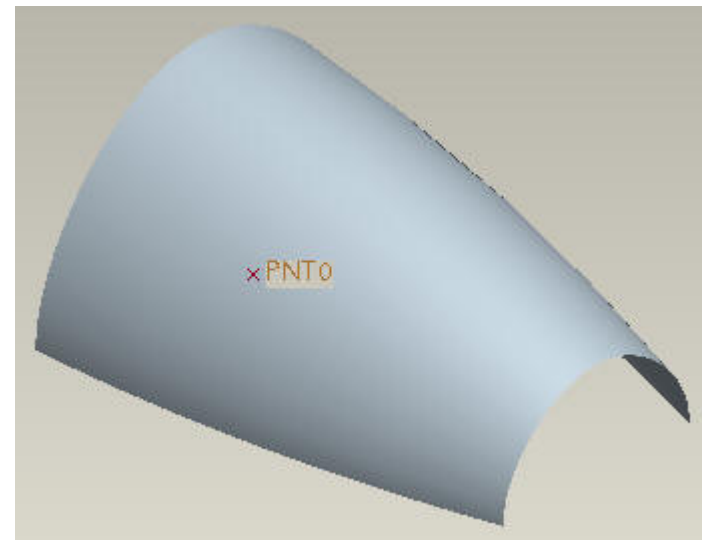

Datum Point lying on a surface

## Datum Planes

In this section, there are several exercises elaborating how to create

- A datum plane that passes through a datum axis and at an angle to a specified plane
- A datum plane that passes through a datum point and normal to a datum curve
- An offset datum plane
- A datum plane that is parallel to an existing plane and passes through a datum curve.

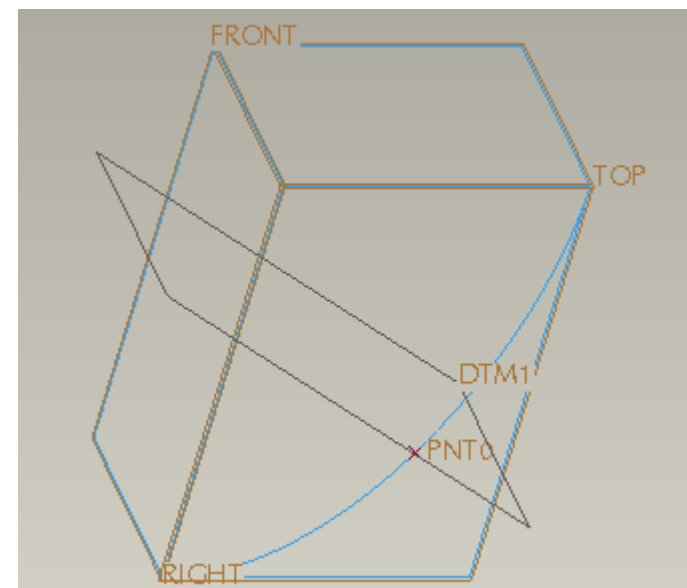

## *Datum Axis*

In this section, there are several exercises elaborating how to create

- A datum axis that passes through the center of a cylindrical surface
- A datum axis that passes through the center of a circular curve.
- A datum axis that passes through a datum point and normal to a datum plane.
- A datum axis that passes through a datum point and normal to selected surface.
- A datum axis that passes through a datum point and tangent to a selected datum curve.
- A datum axis that passes through the intersection of two datum planes.

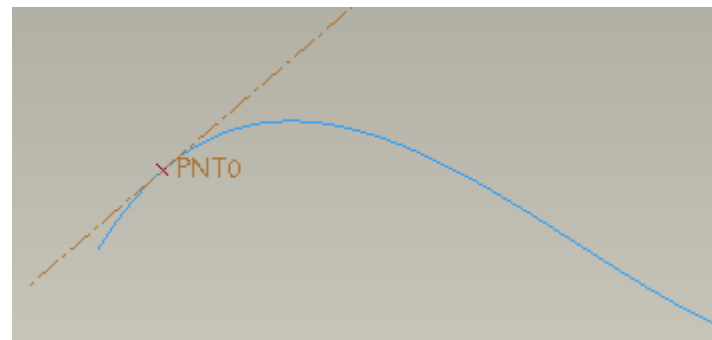
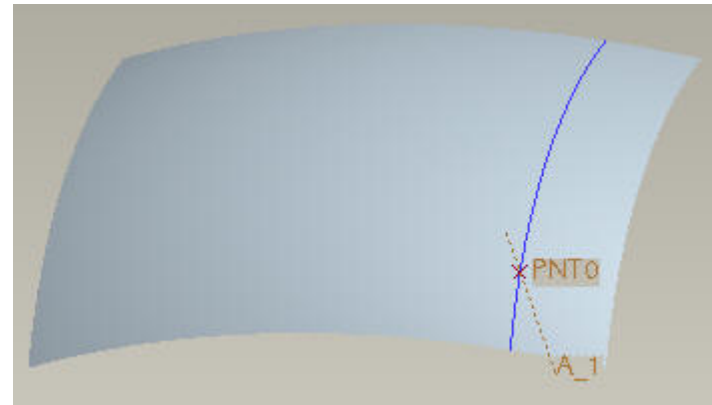

## *Datum Coordinate System*

In this section, there are several exercises elaborating how to create

- A datum coordinate system at the intersection of three datum planes.
- A datum coordinate system at the intersection of an axis and a surface.
- A datum coordinate system offset from an existing coordinate system.
- A datum coordinate system that lies at a vertex and its axis directions parallel to the default coordinate system

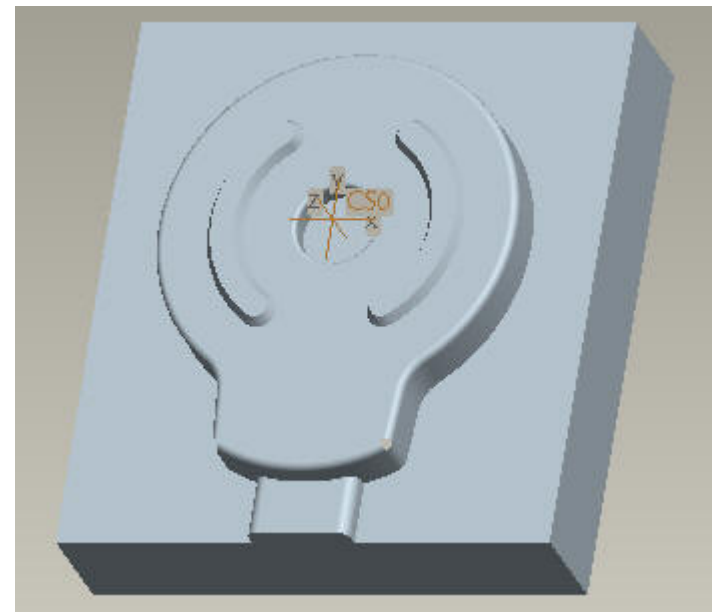

# Surface Quality and Analysis

The quality or smoothness of a surfaces greatly influences the look and in some cases functionality of a product.

In this section we will explain the basic concepts related to the quality of surfaces and elaborate the terms like "radius of curvature" and "curvature continuity" . We will also learn to use the tools offered by Pro/ENGINEER to analyze the surfaces.

## Curve Quality

Most of the surfaces are built around datum curves. So quality of surface directly depends upon the quality of curves.

In this section, there are several exercises elaborating how to

- Analyze a curve using Radius and Curvature analysis tools
- Understand the difference between curvature continuous and discontinuous curves.
- Modify it a curve make it curvature continuous.
- Ttransform the copied curves to a curvature continuous curve

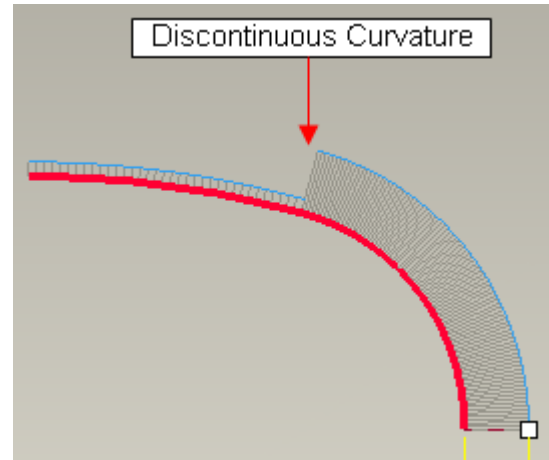

A curvature discontinuous curve

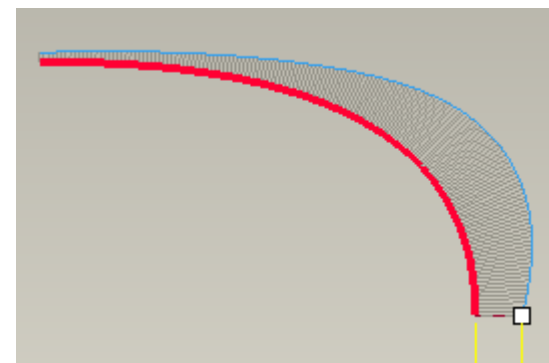

A curvature continuous curve

## Surface Quality

The quality of a surface is determined by the quality of individual surface patches and their connection with each other. A surface analysis is usually performed after curve analysis to check the quality of the surface.

In this section, there are several exercises elaborating how to

- Analyze a curve using Radius and Curvature analysis tools
- Analyze a surface for continuity using Reflection analysis tool
- Analyze a surface using Curvature analysis tool
- Analyze a quilt with Dihedral Angle tool to determine the level of tangency.
- Analyze the Gaussian curvature of a surface
- Analyze the Gaussian curvature of a surface
- Analyze a surface to determine if it has sufficient draft by using Draft Check tool.

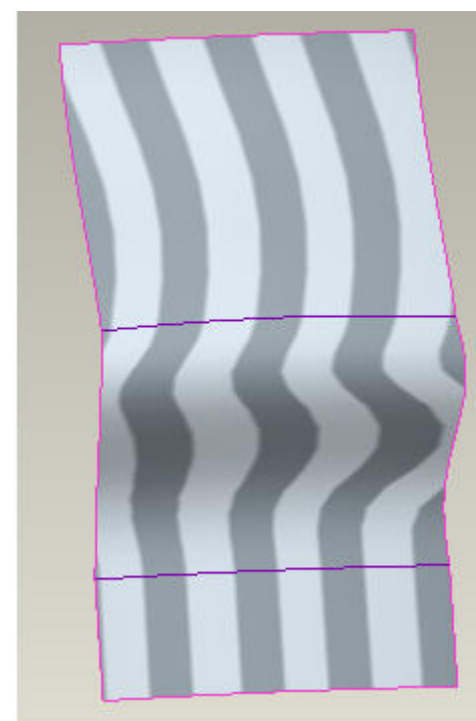

Reflection Analysis

## *Singularity*

A singularity is created when gridlines of a surface concentrate to a single point

Surfaces with singularities are considered to be of poor quality and make the offset, thicken or shell operation very difficult. Furthermore surfaces with singularities are unstable during regeneration.

In this section, we will build two surface models elaborating how to avoid the singularity problems.

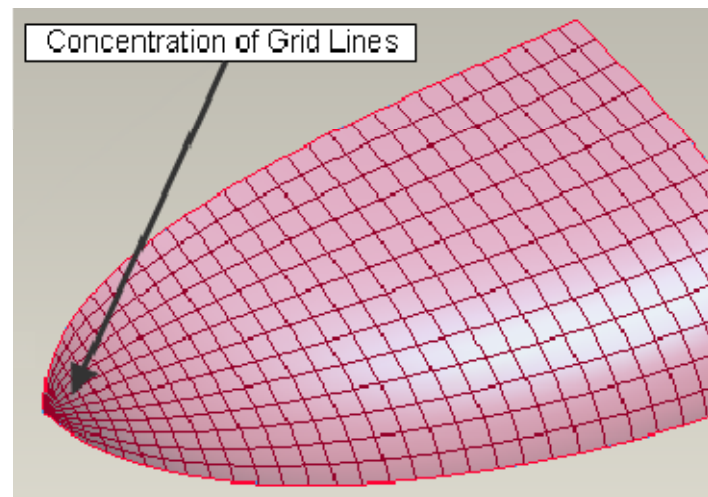

A quilt with singularity

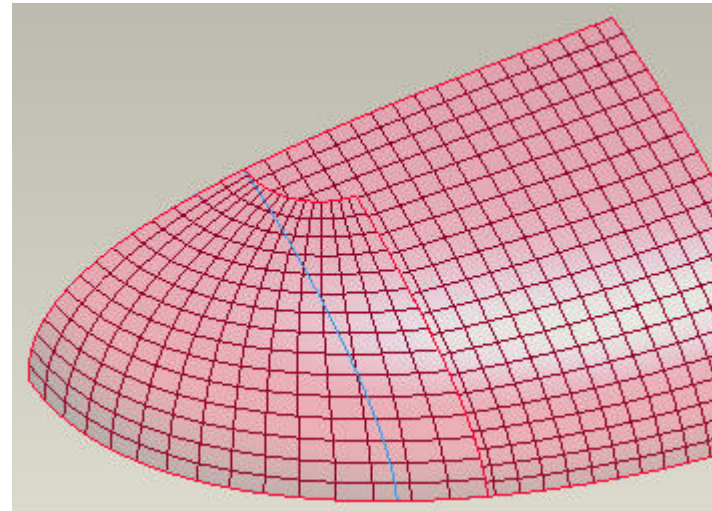

A quilt without singularity

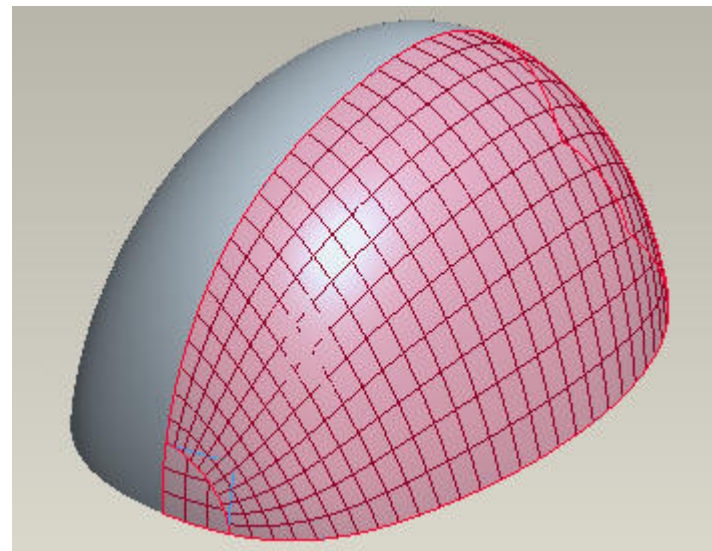

Helmet surfaces meshed: No Singularity exists

# Examples

In this section, techniques learned in previous sections are implemented to create the geometries of real parts. There are total 35 exercises in this section. These exercises have been arranged in increasing order of complexity. This is the most important section of the tutorials.

## Exercise 1

In this exercise we will create a door handle. The topics elaborated are as follows.

- Adding relations in a variable section sweep feature
- Solidifying a quilt

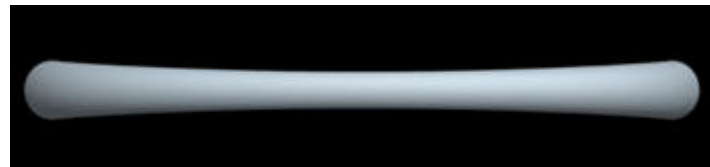

## Exercise 2

In this exercise we will create the surface model of a hand grip. The topics elaborated are as follows.

- Defining the section of a variable section sweep feature with spline
- Controlling tangency dimensions of a spline



## Exercise 3

In this exercise we will learn to fix a distorted boundary blended surface. The topics elaborated are as follows.

- Changing the location of Start Point



## Exercise 4

In this exercise we will create the surface model of a shampoo bottle. The topics elaborated are as follows.

- Defining a boundary blended surface with constraints
- Thickening a quilt



## Exercise 5

In this exercise we will create the surface model for a door of drawer. The topics elaborated are as follows.

- Creating datum curves through existing points
- Applying tangency conditions to the datum curves
- Defining a boundary blended surface with constraints

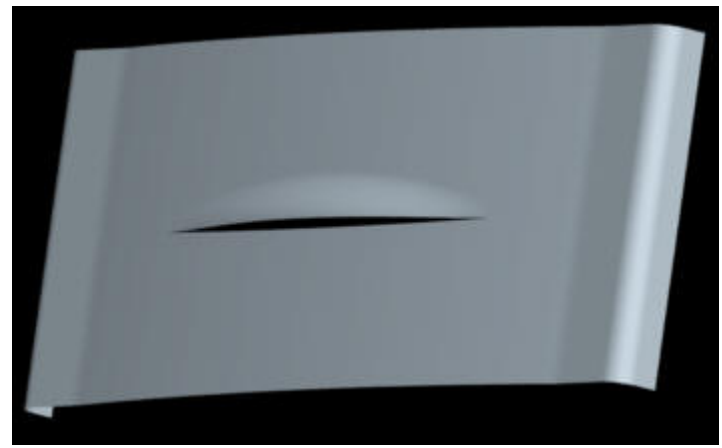

## Exercise 6

In this exercise we will create the surface model for a plastic chair. The topics elaborated are as follows.

- Creating a datum curve that lies on selected surface
- Trimming surface

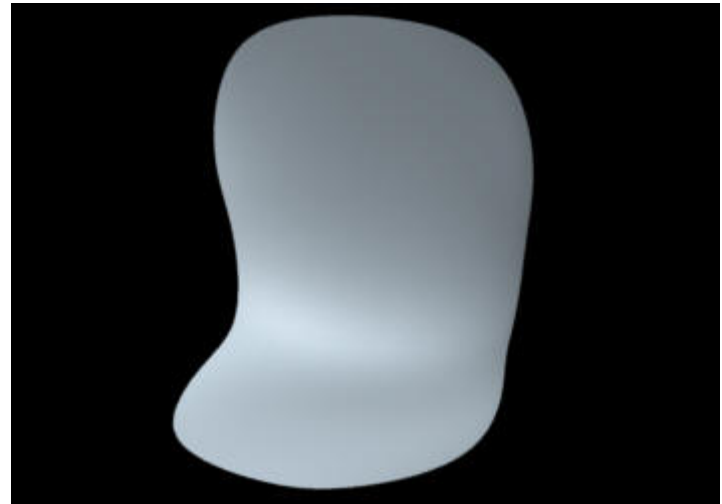

## Exercise 7

In this exercise we will create the surface model for a jug. The topics elaborated are as follows.

- How to make the parent and mirrored surfaces tangent to each other
- Freely tweaking a datum curve
- Trim a surface with projected curve



## Exercise 8

In this exercise we will create the surface model of the scoop for a car. The topics elaborated are as follows.

- Creating a datum curve through multiple datum points
- For a surface to be normal or tangent to a reference, underlying datum curve must also be normal or tangent, respectively to the reference.



## Exercise 9

In this exercise we will create the surface model of the pulsator for a washing machine. The topics elaborated are as follows.

- Mapping points for boundary blended surface
- Pattern a surface



## Exercise 10

In this exercise we will create the surface model of a channel. The topics elaborated are as follows.

- Why it is advantageous to pick the surface edge instead of underlying datum curve for creating a boundary blended surface.
- How to make the side edges of the blended surface tangent to the side edges of the reference surfaces.
- How to control the influence of reference surfaces while creating a boundary blended surface

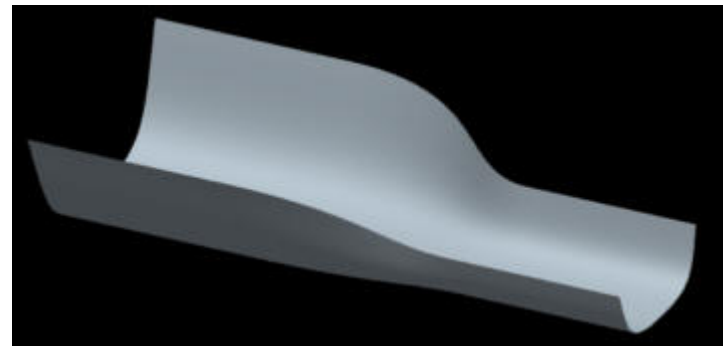

## Exercise 11

In this exercise we will create the surface model of a mobile phone. The parting surface of the part is non-planar. It will be shown how to build draft into the surfaces instead of using Draft Tool. The topics elaborated are as follows.

- How to build draft angle in the definition of variable section sweep surface
- How to achieve constant draft angle for complex split-surface assemblies

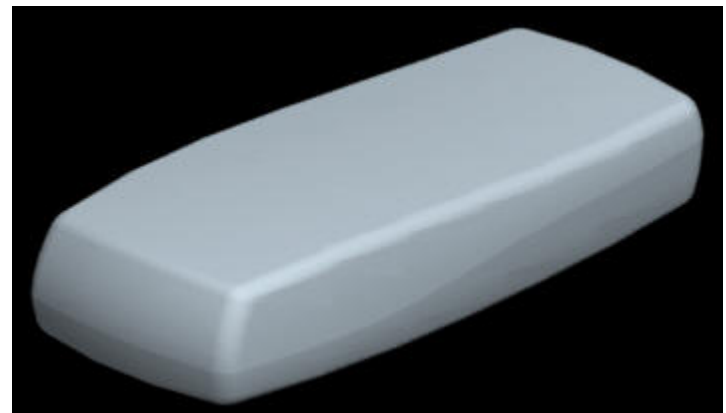

## Exercise 12

In this exercise we will create the surface model of a receiver. The topics elaborated are as follows.

- How to make variable section sweep surface tangent to adjacent surfaces while maintaining constant draft angle
- Analyzing a part for sufficient draft

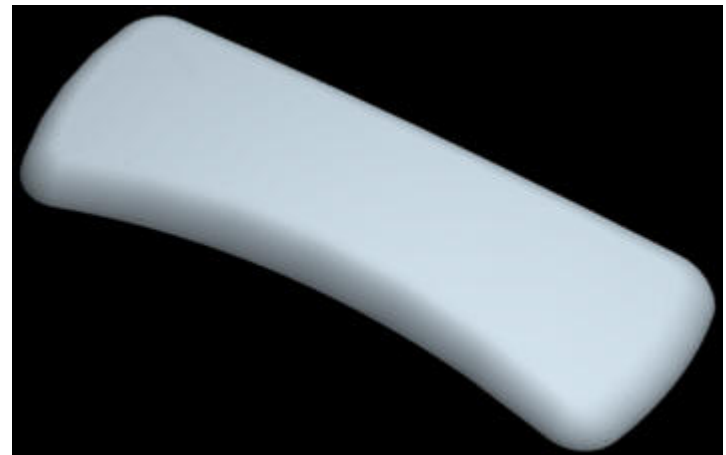

## Exercise 13

In this exercise we will create the surface model of a mobile phone. The parting surface of the part is non-planar. It will be shown how to build draft into the surfaces instead of using Draft Tool. The topics elaborated are as follows.

- How to build draft angle in the definition of boundary blended surface
- How to achieve constant draft angle for complex split-surface assemblies
- Getting better quality surfaces by choosing suitable blending option



## Exercise 14

In this exercise we will create the surface model of a torch. The topics elaborated are as follows.

- How to build draft angle in the definition of boundary blended surface
- Mapping of boundary blended surface at custom defined control point

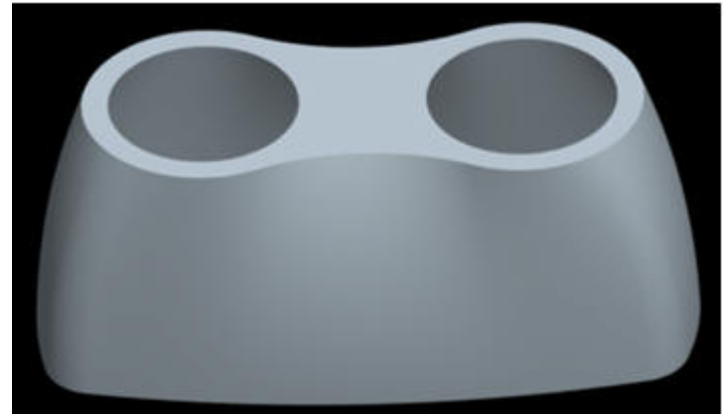

## Exercise 15

In this exercise we will create an indent in the surface model of a component.

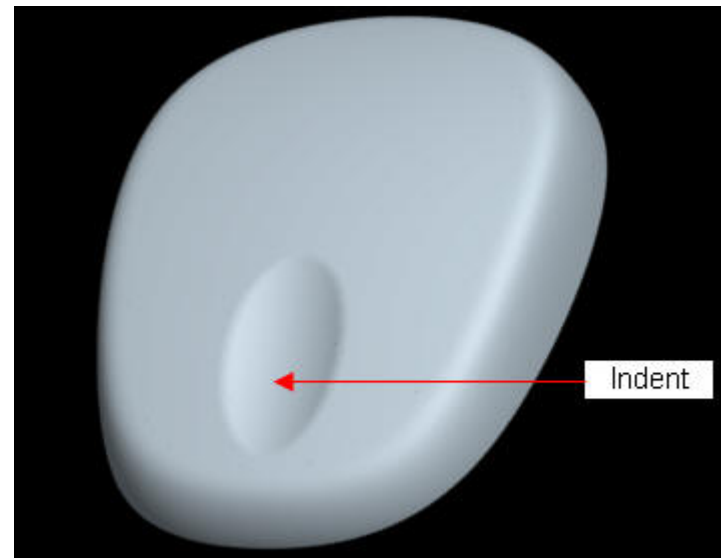

## Exercise 16

In this exercise we will create an indent in the surface model of a component. If a boundary blended surfaces is created between two existing surfaces, both have influence on the shape of the surface. This influence can be controlled to get ergonomic surfaces. The topics elaborated are as follows.

- Creating curvature continuous surfaces
- Creating curvature continuous rounds
- How to control the influence of reference surfaces while creating a boundary blended surface

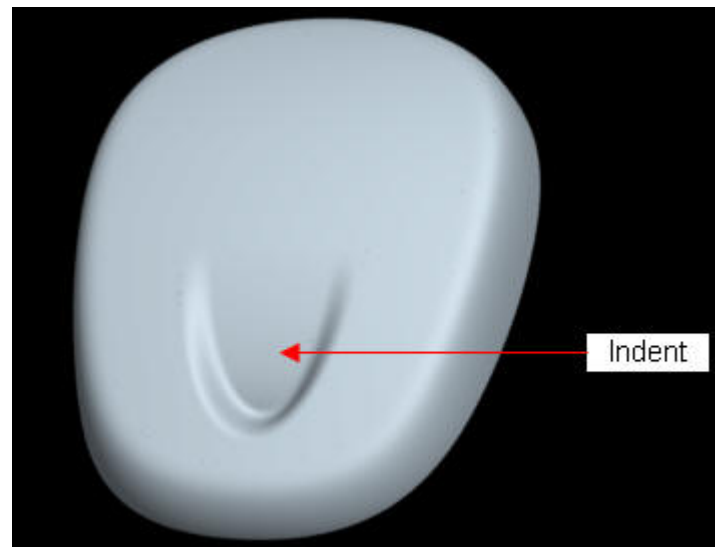

## Exercise 17

In this exercise we will create an indent behind the car door handle. The round shown is not created with Round tool instead boundary blended surface is fine tuned to give the effect of round. The topics elaborated are as follows.

- Creating curvature continuous rounds
- Getting better quality surfaces by choosing suitable blending option
- How to control the influence of reference surfaces while creating a boundary blended surface

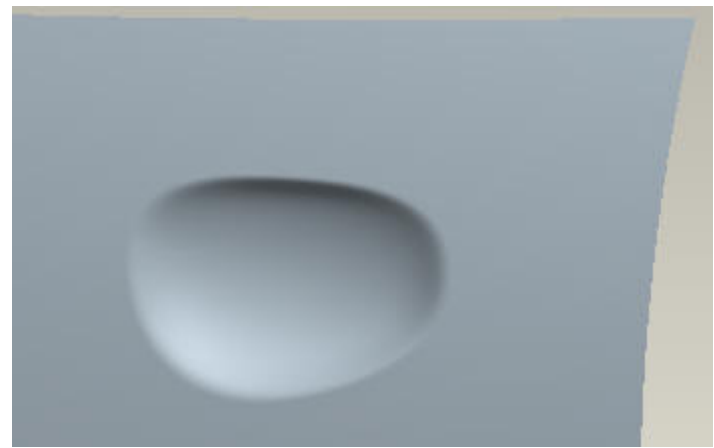

## Exercise 18

In this exercise we will create the surface model of a spoon. The topics elaborated are as follows.

- How to achieve "implied tangency" while creating symmetrical parts.
- Avoiding singularities



## Exercise 19

In this exercise we will create the surface model of a clock. The topics elaborated are as follows.

- For a surface to be normal or tangent to a reference, underlying datum curve must also be normal or tangent, respectively to the reference.
- Pattern a surface
- Maintain tangency across patterned surfaces
- Analyzing the quilt with Dihedral Angle tool to determine the level of tangency

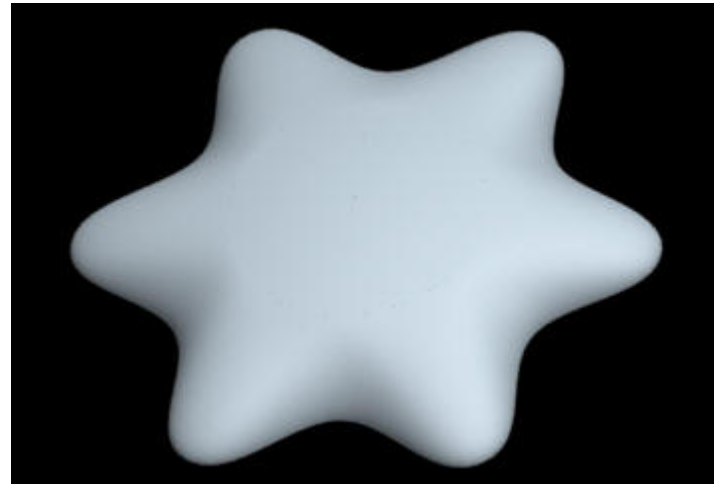

## Exercise 20

In this exercise we will create the surface model of a fan base. Here a lot of techniques learned in previous exercises are implemented together. The topics elaborated are as follows.

- How to achieve "implied tangency" while creating symmetrical parts.
- Avoiding singularities
- Creating rounds with boundary blended surfaces instead of Round Tool
- Analyzing the quilt with Dihedral Angle tool to determine the level of tangency

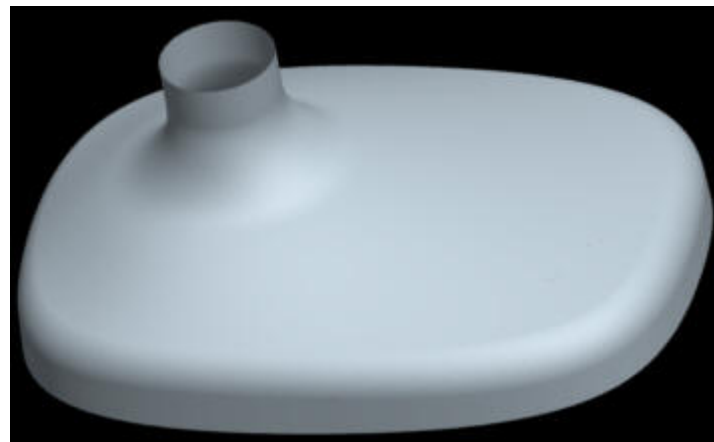

## Exercise 21

In this exercise we will create a pipe intersection of different cross-sections. The new techniques learned here are as follows.

- How to constrain a datum curve in a specified plane or surface
- Taking advantage of multiple symmetries in a part

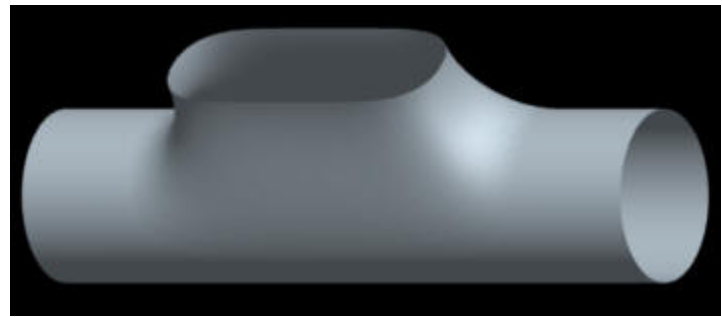

## Exercise 22

In this exercise we will create a pipe intersection of "Y" shape. The topics elaborated are as follows.

- Creating surfaces for gaps requiring five sided boundary blended surface
- Trimming surfaces to achieve favorable geometry for a four chain boundary blended surface

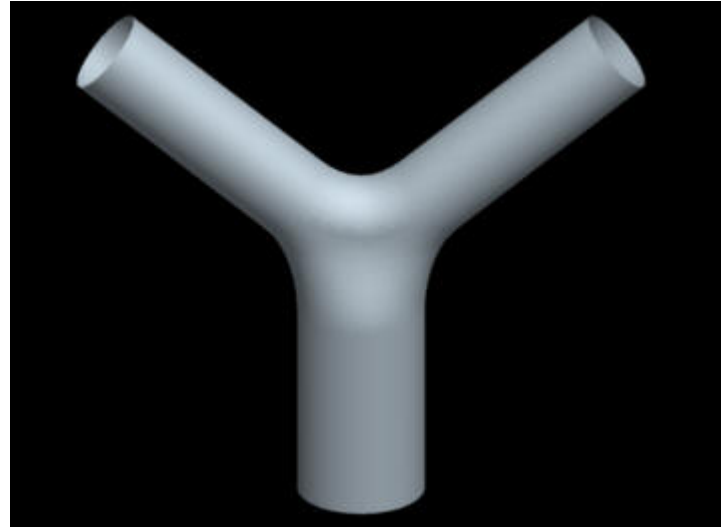

## Exercise 23

In this exercise we will create a pipe intersection of multiple cross-sections. The new techniques learned here are as follows.

- Fixing degenerate surfaces
- Inserting curves in boundary blended surface

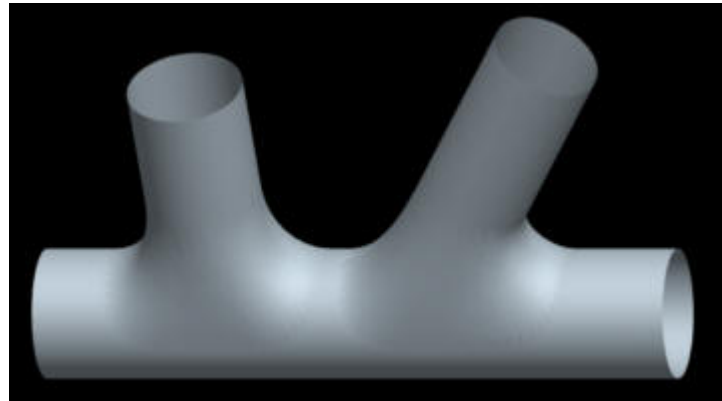

## Exercise 24

In this exercise we will create a model for soup spoon . The new techniques learned here are as follows.

- Avoiding singularities in non-symmetric parts
- Trimming surfaces to achieve favorable geometry for a four chain boundary blended surface

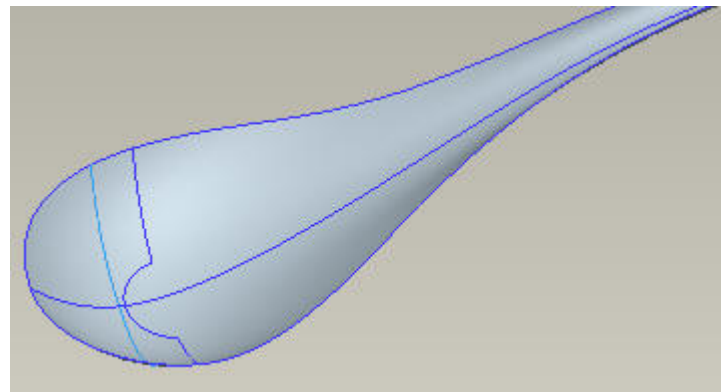

## Exercise 25

In this exercise we will create a model of bicycle headlight. The new techniques learned here are as follows.

- How to make a curve normal to a selected edge and at the same time tangent to a surface
- Creating rounds with boundary blended surfaces instead of Round Tool

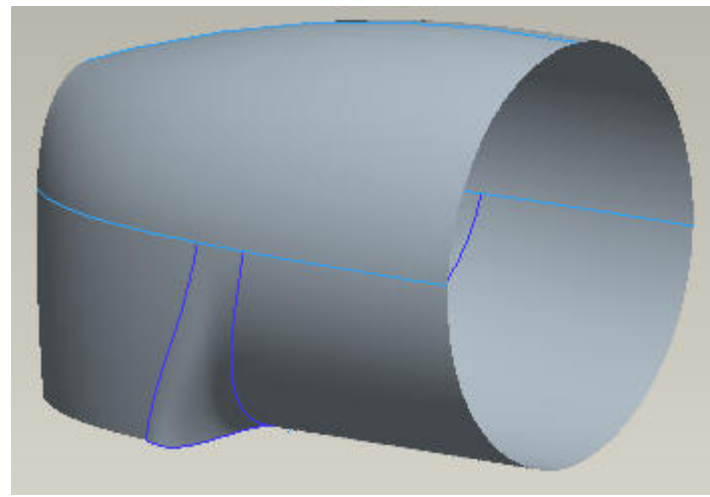

## Exercise 26

In this exercise we will create a surface model of an electric iron. The topics elaborated are as follows.

- Trimming surfaces to achieve favorable geometry for a four chain boundary blended surface
- How to make a curve normal to a selected edge and at the same time tangent to a surface

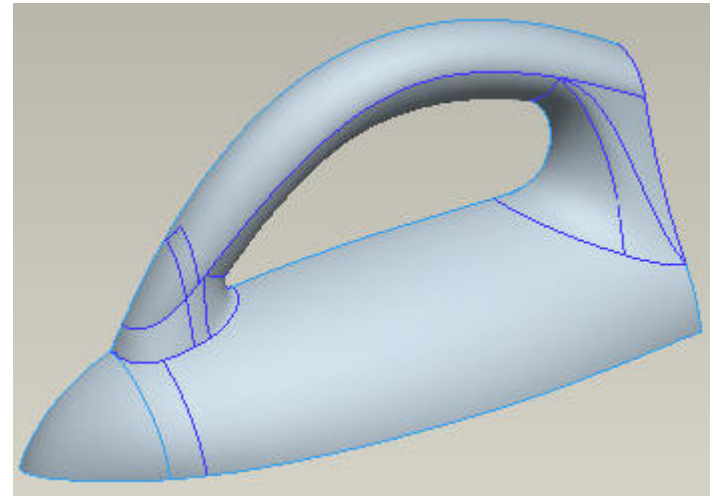

## Exercise 27

In this exercise we will create a model of binocular. The topics elaborated are as follows.

- Creating surfaces for gaps requiring five sided boundary blended surface

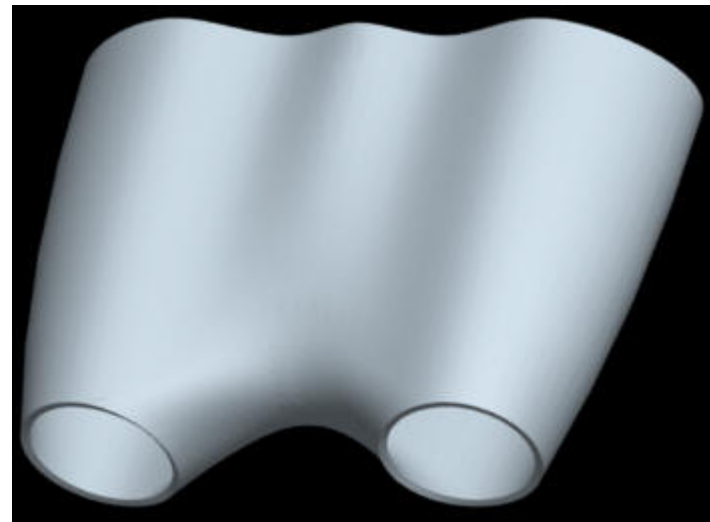

## Exercise 28

In this exercise we will create a surface model of sink mixer. The new techniques learned here are as follows..

- Using Ribbon Surface to make surfaces tangent while minimizing parent -child relations



## Exercise 29

In this exercise we will create a model for a bicycle seat. It will also be shown how to convert a quilt into a solid and then shell it out to achieve uniform thickness solid parts.

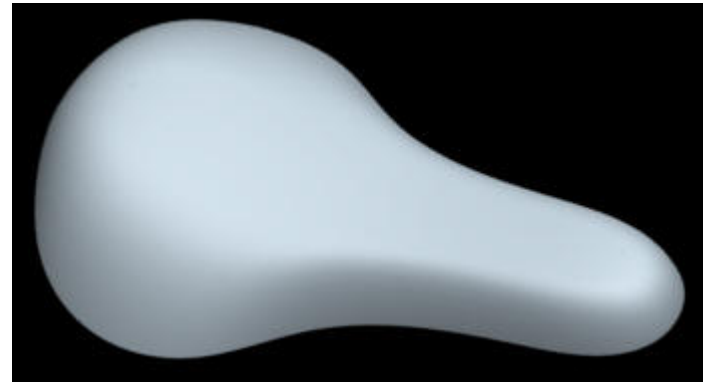

## Exercise 30

In this exercise we will create another model for a bicycle seat. Here all the surfaces will be curvature continuous to each other. A new technique will be introduced to achieve desired reflective behavior of surfaces and avoid singularity.



## Exercise 31

In this exercise we will create a surface model for a shower head. The most important aspect is building draft so that geometry is manufacturable. Here a lot of techniques learned in previous exercises are implemented together.



## Exercise 32

In this exercise we will create a model for a shoe. The most important aspect is to constrain the movement of curve in a single plane while tweaking. It will also be shown how the blending options of boundary blended surface affects the quality of resultant surface. Here solidify and thicken operation will be performed in a same part.



## Exercise 33

In this exercise we will create a model for a car roof. The most important aspect is the additional control of tweaking functionality.

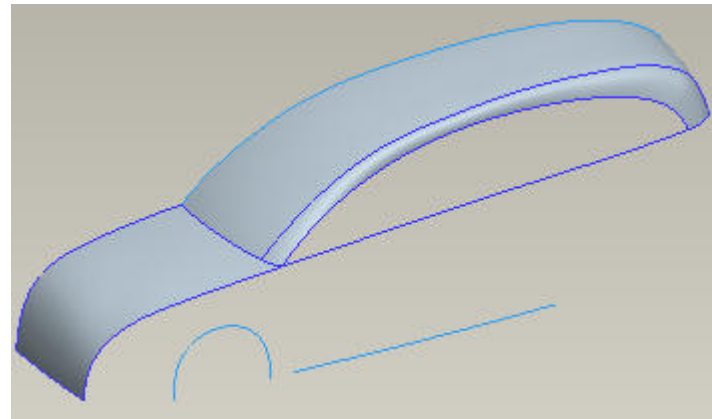

## Exercise 34

In this exercise we will create a model for a car fender. Here a lot of techniques learned in previous exercise are implemented together.

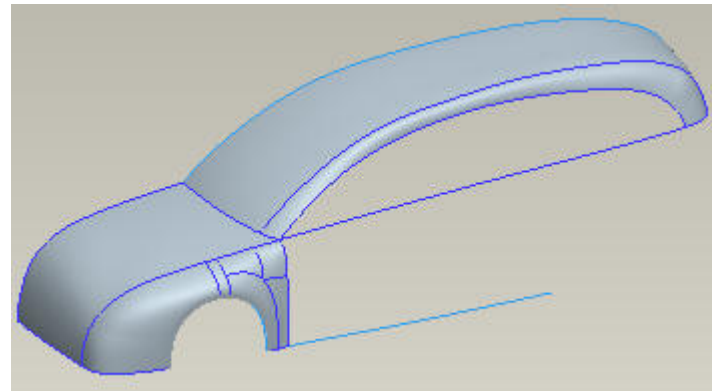

## Exercise 35

In this exercise we will create a model for an axial fan. Here graph feature will be used with Variable section sweep feature to create highly complex geometry of the blade.

